

# WECON IIOT PRODUCTS AND SOLUTIONS

● Understand Industrial Status ● Integration of Industry Needs ● Creative Solutions



**WECON**<sup>®</sup>  
Wecon Technology Co.,Ltd.



Addr1:10th Building,E Area,Software Park, Fuzhou,Fujian,China(Manufacturing Center)

Addr2: 6th Building,F Area,Software Park,Fuzhou,Fujian,China(R & D Center)

Tel:+86-591-87868869 ext 894 Fax:+86-591-87843899

Website:www.we-con.com.cn/en

Email: sales@we-con.com.cn skype:lily-wecon



2020 Edition

WECON TECHNOLOGY Co.,LTD.All Rights Reserved.



## CONTENTS

● Contents .....	001
● Preface .....	002
● V-NET .....	003
● V-NET Application .....	005
● V-BOX .....	006
● Cloud-Mode and Data-Mapping .....	007
● Features .....	008
● Specifications .....	009
● Installation Dimensions .....	012
● Applications .....	013
● Appendix: PLC& Protocols Supported .....	017

## What WECON IIoT can do?

### Machine Makers——

If your machines are sold all over your country or globally, the remote after-sales service and management will be realized in this era. As long as your machine have equipped with a V-BOX, it can be remotely debug, configure and manage on V-NET after simple configuration.

V-NET provides a convenient, cost-effective cluster management solution for your machines.



### Industrial IoT Platform Operators——

If your platform provides a perfect dedicated IoT solution for all kinds of industries, such as Special Equipment Safety Industry, Intelligent Agriculture, Tower Cranes, Smart Parking, etc., but it faces enormous challenges in solving "the last one mile" access difficulties, facing a variety of PLC brands and user devices, how to get their data becomes the most cumbersome and necessary problem to be solved.

V-BOX's Cloud-Mode can easily solve the device access problems.

### System integrator——

You want to provide automation solutions or implement MES system for your clients, such as installing a robotic arm for a puncher. In order to improve automation efficiency, it is necessary

to solve the linkage work between the robot and the punch. At this time, you need to solve the following problems:

Machine to Machine Talk (M2M)

Machine to System Talk (M2S)

This problem can be solved by configuring V-Box in the LUA script. It can be done directly without any platform to complete data transfer.





Developing various industrial IoT application on users' demand on V-NET.

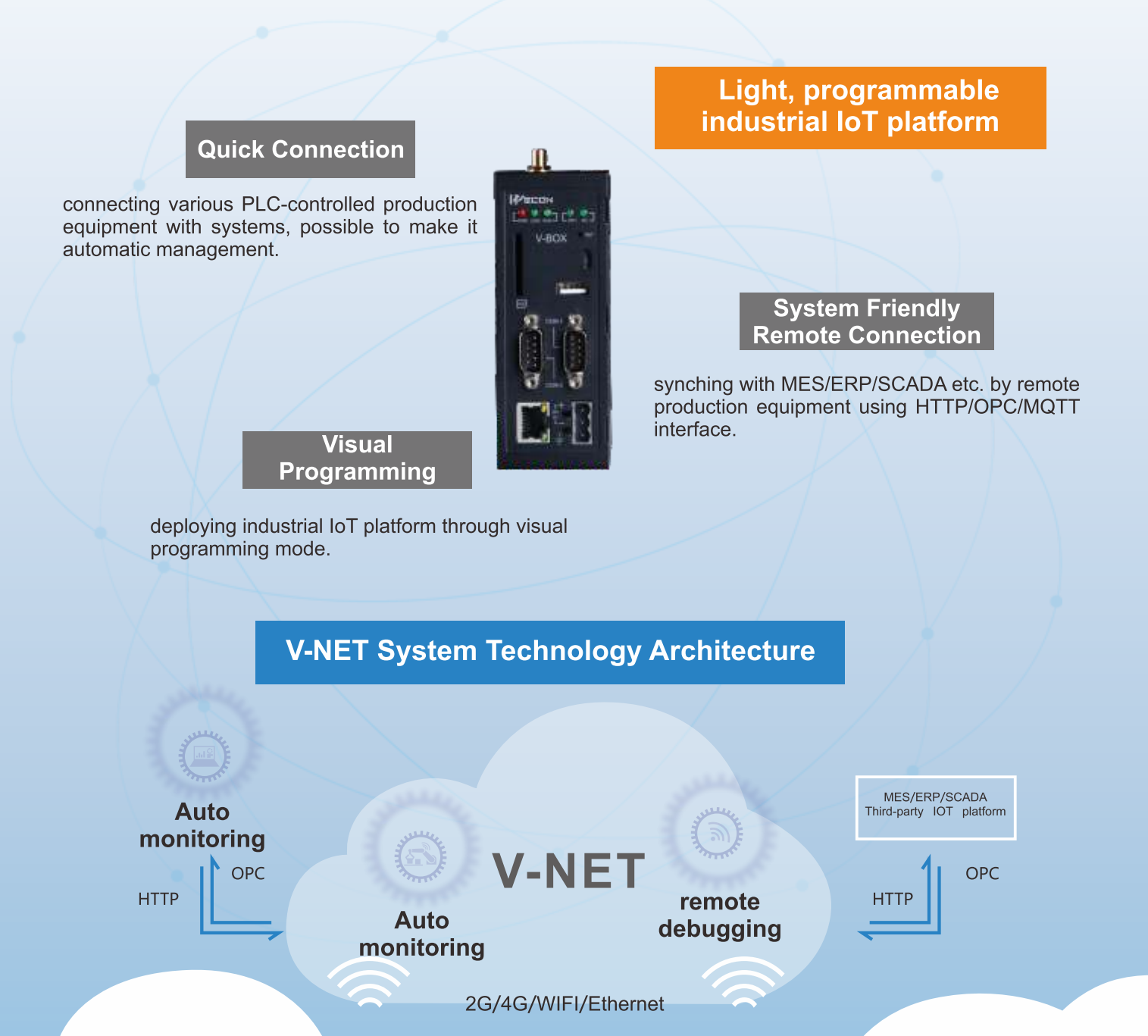

## V-BOX(S series,E series,H series V-Box)

- Smart greenhouse
- Sewage treatment
- Heating equipment
- Packing machine
- Wind Turbines
- Intelligent agriculture
- Medical equipment
- Robotic arm

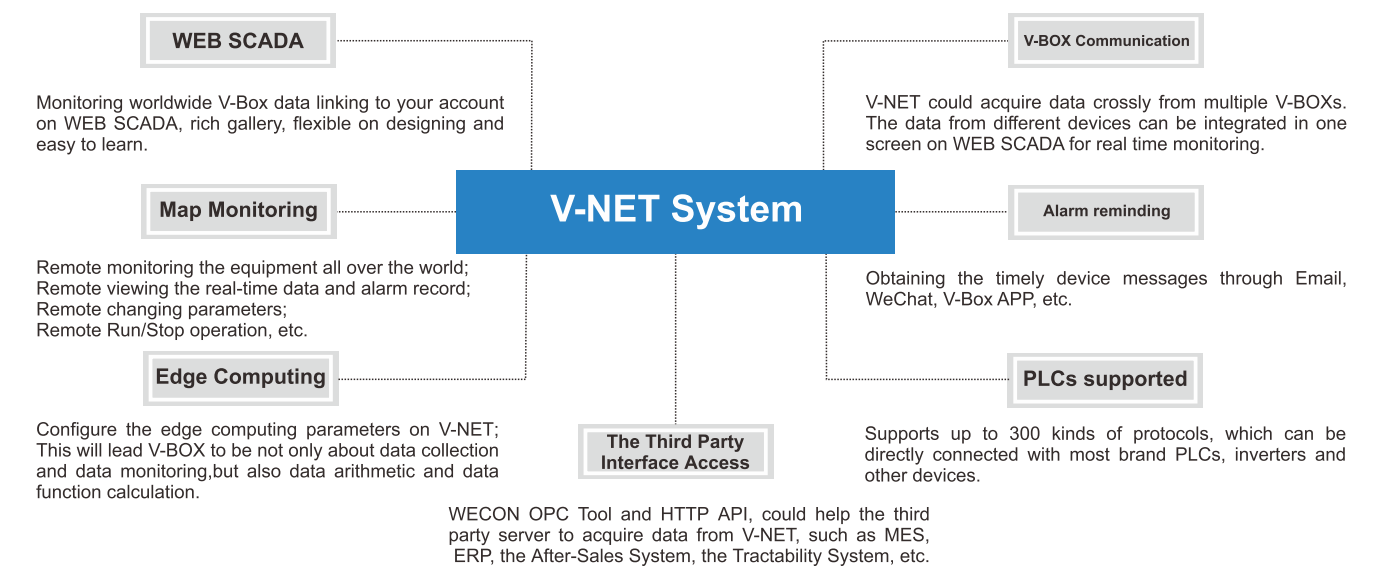

## V-NET System Advantages

- Open**
  - Supports up to 300 kinds of protocols and PLCs.
  - Easily communicate with third-part software and Cloud Platform.
  - Introduce third-party software to customize special business requirements.
- Flexible**
  - V-BOX SCADA: The data from different devices can be integrated in one screen in the V-cloud;
  - Communicate between V-BOX and V-BOX: realize communication between V-BOX and V-BOX.
- General**
  - As the general IIoT system, V-NET offers basic devices connection service.
  - Also, clients can deploy own industrial IoT platform through visual programming mode.
- Security**
  - All "Manager account" are separated from the "view account" for each function.
  - Communication mode encryption to ensure security.
  - Many kinds of reminds through remote control to ensure safe execution.

## How to Corporate

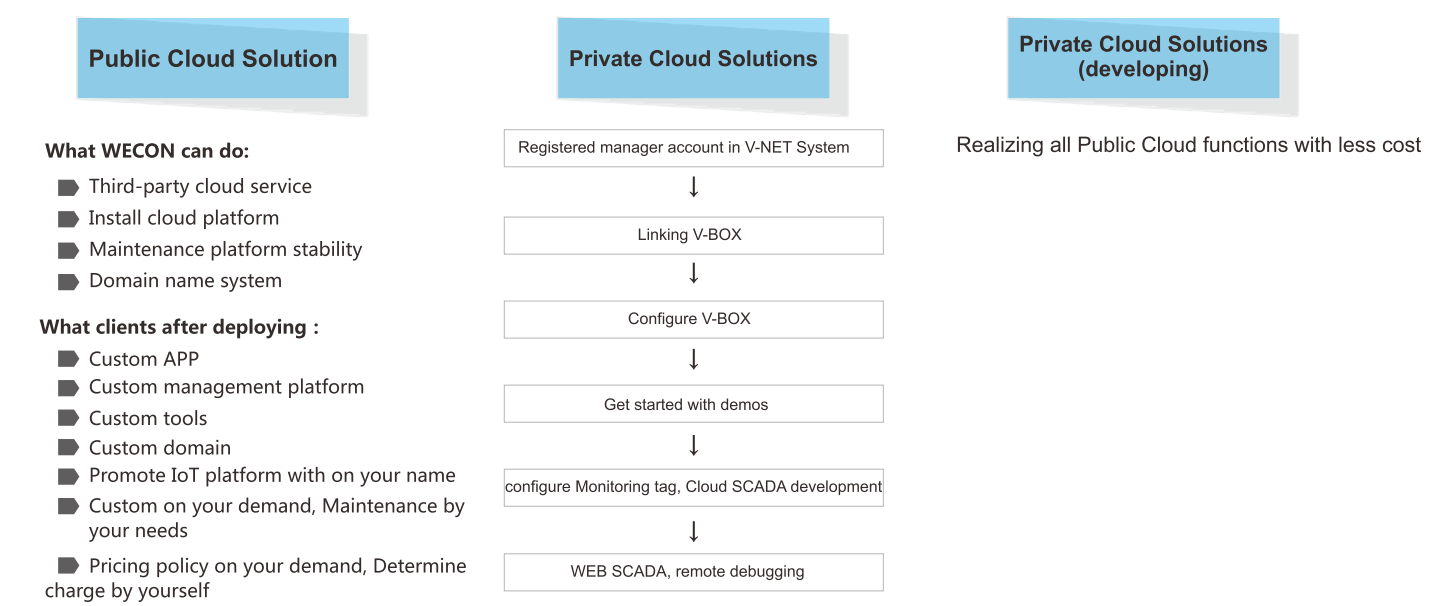

# V-NET Applications

## Auto Monitoring

connecting various PLC-controlled production equipment with systems, possible to make it automatic management.

- V-BOX SCADA
- Exquisite pictures
- Alarms reminding
- Cloud data saving
- Most brands of PLC supported
- Off-line Transmission

WECON V-NET System provides you with the best unattended monitoring solution, and all you have to do is adding one V-BOX to each of your controlled devices.

## Remote Debugging

Even if you are far away from the factory, in case of emergency, without your engineers, V-BOX could support PLC remote download, debug to resolve any problems.

- PLC connection through the Ethernet / serial port.
- Transferring, remote download and debugging can be realized through VPN data service.
- Remote video monitoring to help you understand the situation on the spot.

All you have to do is adding one V-BOX to each of your controlled devices.

## System Remote Connection

If you or your clients have MES, ERP, SCADA, operation and maintenance systems or private clouds, but do not know how to make these costly systems directly connect to automated production equipment, V-NET offers suitable solutions.

- V-NET System OPC interface, realizing remote data interaction between SCADA system and controlled device.
- Connecting to V-BOX and IIoT platform using MQTT directly, safely and quickly.
- With built-in LUA scripts, users can customize MQTT according to actual needs.

All you have to do is adding one V-BOX to each of your controlled devices.

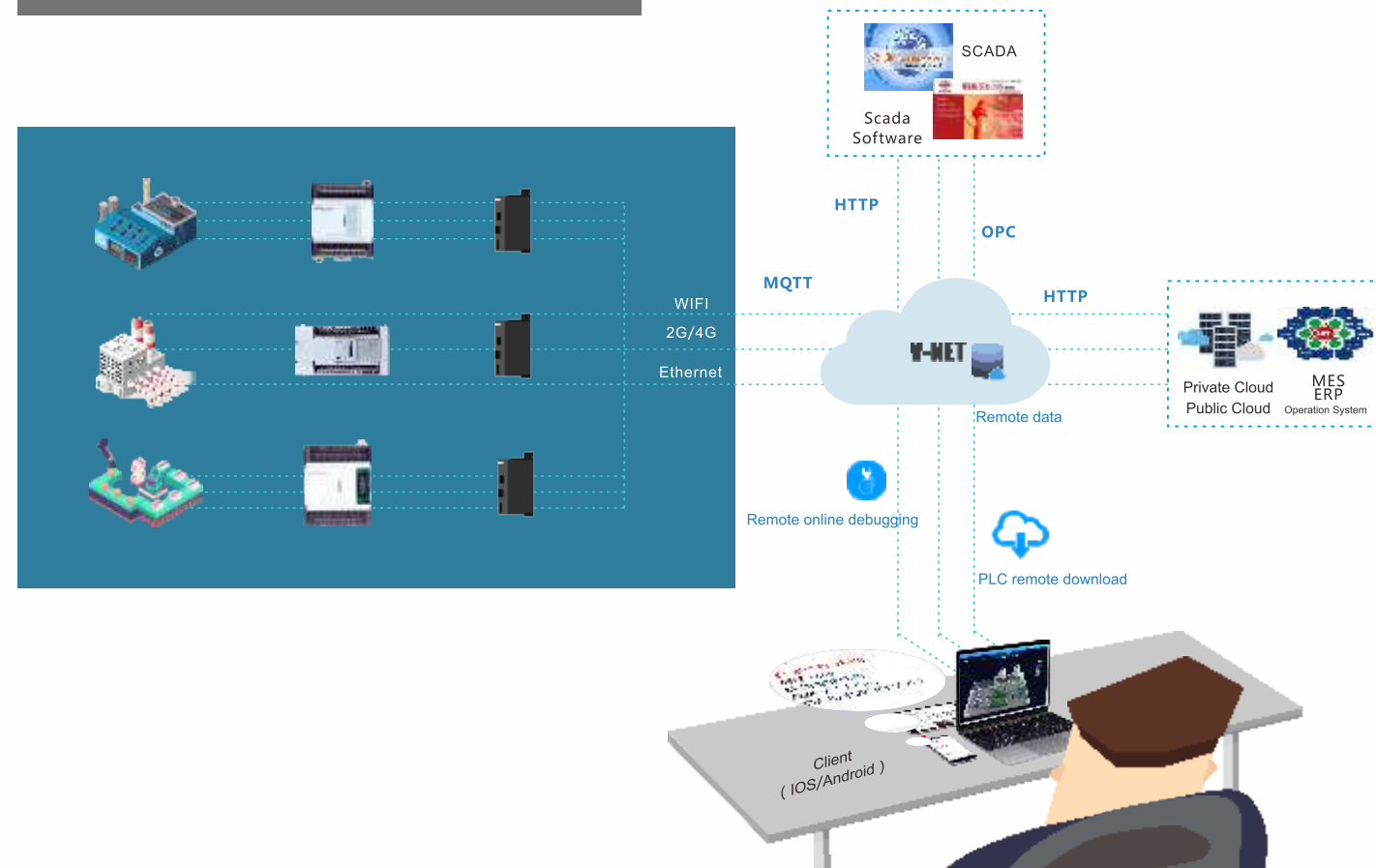

# V-BOX

## V-BOX Introduction

V-BOX has S Series E Series and H Series and each series V-BOX can support three application modes. The V-BOX is the basic hardware of the Industrial Internet of Things. It is an indispensable information exchange and protocol conversion device for the IoT cloud platform to communicate with the system. In addition, WECON LCM series remote IO module can communicate directly with V-BOX, without PLC, and implements simple logic control and analog acquisition using edge computing.

## Operating mode

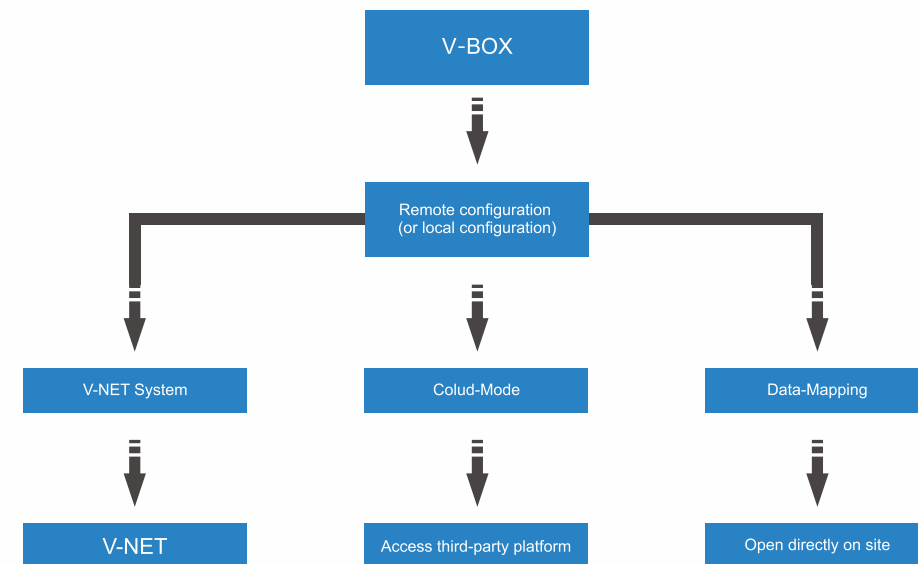
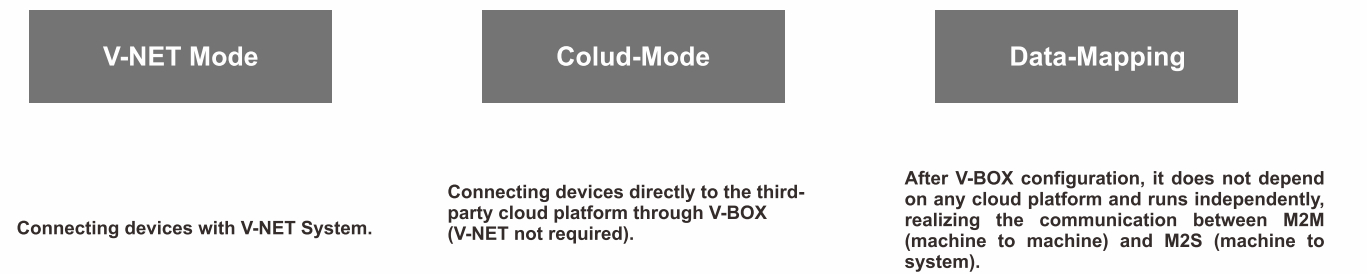

## Switch mode

- Each V-BOX can use any of the Cloud-Mode, V-NET System and Data-Mapping;
- Cloud-Mode can be exchanged to V-NET System;
- Data-Mapping features supported in all V-Box;
- Cloud platform not required in Data-Mapping Mode.

# Cloud-Mode and Data-Mapping

## Cloud-Mode

Syncing data in devices with on-demand cloud platform directly under Cloud-Mode.

### Cloud-Mode Features

- Independent configuration/running process: configuration process refers to the process required for device connected to the cloud platform. Configuration status is disabled when it completes. Running process is for data synchronization which keeps updating;
- Developer: Syncing data in devices with on-demand cloud platform by using LUA script, according to MQTT Structure;
- Built-in PLC protocol: Syncing data by choosing suitable PLC protocol;
- Market protection: Only the V-Box in Cloud-Mode could connect to targeted cloud platform.

### Cloud-Mode Configuration Center

- Convenient and fast remote configuration, no matter where the V-BOX is, click on the mouse to configure;
- Built-in configuration management function, save multiple configurations for quick use of the V-BOX;
- Configuration center can be embedded into industrial IoT platform on Cloud-Mode;
- Configuring V-BOX by using mini USB or local area network;
- Enable remote configuration features on demand.

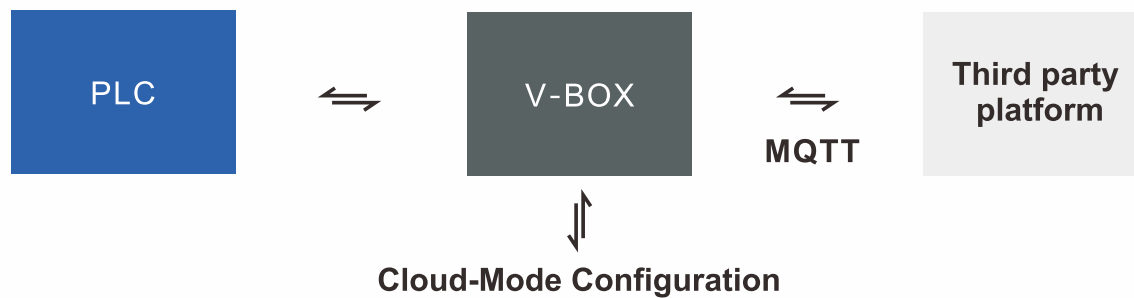

## Data-Mapping

Communicating with MES/SCADA system with proper configuration, no cloud platform and Internet required.

### Data-Mapping Features

- Syncing data between different PLC protocols by using LUA script, real-time response.
- Configure Data-Mapping features from either local area or remote network.
- Convert a variety of PLC protocol into standard protocol such as Modbus
- Convert a variety of PLC protocol into specify protocol including MQTT, WEBSERVEICE.
- Data-Mapping features supported in all V-BOX modes including V-NET Mode and Cloud-Mode.

# Features

Model	S Series	E Series	H Series
<b>Enclosure</b>	Aluminium alloy	Metal	ABS
<b>Network Connecting</b>	4G/4G Global/ WIFI/Ethernet	2G/4G/4G Global/ Ethernet	4G/4G Global/ WIFI/Ethernet
<b>I/O Ports</b>	N/A	N/A	2 inputs with optocoupler isolation 2 relay output
<b>Serial Port</b>	COM1: RS232/RS485/RS422 COM2: RS232/RS485 COM3: RS485	COM1 : RS232 , RS422/RS485	1 WAN+2 LAN in switch mode
<b>Mounting</b>	Din rail/screw	Din rail	Din rail/screw
<b>Service Mode</b>	V-NET/Cloud-Mode /Data-Mapping	V-NET/Cloud-Mode /Data-Mapping (Note: specified model supported)	V-NET/Cloud-Mode /Data-Mapping
<b>Functions</b>	Remote configuration, remote debugging, Script	Remote configuration, remote debugging, Script (Note: specified model supported)	Remote configuration, remote debugging, Script
<b>Service Protocol</b>	MQTT, MODBUS TCP, etc. Breakpoint continuous transimission Service protocols development on demand		
<b>Device Protocol</b>	300 PLC protocols supported i.e. PLC/HMI/VFD/Meters. Device protocol development on demand		
<b>Modules</b>	LCM series IO modules supported for logical operation		

Note: 4G Global version supports all 4G frequency bands in theory. Please contact with us for more help.

# Specifications

General								
Model		S-00	S-AG	S-3N	S-NG	S-PG	S-SG*	
Hardware	OS	Linux						
	CPU	Cortex A8 600MHz						
	Storage	Flash	128MB					
		RAM	DDRIII 128MB					
		SD Card	YES					
	Ports	USB Host	USB 2.0 × 1					
		USB Client	DEVICE USB × 1					
		Serial Port	COM1 : RS232/RS485/RS422			COM1 : RS232/RS485/RS422		
			COM2 : RS232/RS485	COM1 : RS232, RS422/RS485		COM2 : RS232/RS485		
			COM3 : RS485			COM3 : RS485		
		Ethernet	1 Ethernet Port		3 Ethernet Ports		1 Ethernet Port	
		WIFI Module	YES					
		2G/4G Module	N/A	4G Global	N/A	4G	4G Global	4G Global
	Power	Power Supply	24VDC (12~28VDC)					
		Power Consumption	<10w					
	Dimension	Enclosure	Aluminum					
		Dimension (W*H*D)	128.0mm*119.0mm*44.3mm					
		Weight (KG)	0.34					
	Environment	Vibration Resistance	IEC61131-2 Standard					
		Storage Temperature	-20°C~70°C					
Working Temperature		-10°C~60°C						
Relative Humidity		10~85%RH (Non-condensing)						
CE Certification		CE Marked						
FCC Certification		FCC Class A						
Software	Real-time Monitoring Points	300	500	600			500	
	Alarm Monitoring Points	200	300	300			300	
	History Monitoring Points	50	100	100			100	
	History Storage	90 days	180 days	180 days			180 days	
	Normal Pass-through	YES						
	VPN Pass-through	N/A					YES	
	Edge Computing	YES						
	API Interface	YES						
	Remote Update	YES						
	Configuration download / upload	YES						
Off-line Transmission	YES							
GPS	Optional					YES		

# Specifications

General					
Model		E-00	E-2G	E-4G*	
Hardware	OS	Linux			
	CPU	ARM9 300MHz			
	Storage	Flash	128MB		
		RAM	DDRIII 64MB		
		SD Card	N/A		
	Ports	USB	OTG USB / DEVICE USB		
		Serial Ports	COM1 : RS232, RS422/RS485 (2 in 1)		
		Ethernet	1 Ethernet port		
		WIFI Module	N/A		
		2G/4G Module	N/A	2G	4G
	Power	Power Supply	24VDC (12~28VDC)		
		Power Consumption	<10w		
		Enclosure	Metal		
	Dimension	Dimension (W*H*D)	118.6mm*87.0mm*26.8mm		
		Wall Hanging Dimension	110.0mm*15.6mm		
		Weight (KG)	0.26		
	Environment	Vibration Resistance	IEC61131-2 Standard		
		Storage Temperature	-20°C~70°C		
		Working Temperature	-10°C~60°C		
		Relative Humidity	10~85%RH (Non-condensing)		
CE Certification		CE marked			
FCC Certification		FCC Class A			
Software	Real-time Monitoring Points	200	230	250	
	Alarm Monitoring Points	50	60	100	
	History Monitoring Points	20	30	50	
	History Storage	60 days	90 days	90 days	
	Normal Pass-through	YES	N/A	YES	
	VPN Pass-through	N/A			
	Edge Computing	N/A	N/A	YES	
	API Interface	YES			
	Remote Update	YES			
	Configuration download / upload	YES			
Off-line Transmission	YES				
GPS	Optional				

\*:in developing

# Specifications

General		 **:in developing				
Model		H-00*	H-WF*	H-4G*	H-AG*	
Hardware	OS	Linux				
	CPU	Cortex A7 528MHz				
	Storage	Flash	128MB			
		RAM	DDRIII 128MB			
	Ports	MICRO USB	HOST/DEVICE: USB OTG Switch			
		Serial Port	COM1: RS232, RS422/RS485 (2 in 1)			COM2: RS485
			RS485(2 in 1)			COM2: RS485
		Ethernet	3 Ethernet Ports			
		WIFI Module	N/A	YES	N/A	N/A
		2G/4G Module	N/A	N/A	4G	4G Global
		I/O	2 inputs with optocoupler isolation; 2 relay outputs			
	Power	Power Supply	24VDC (12~28VDC)			
		Power Consumption	<10w			
	Dimension	Enclosure	PC+ABS			
		Dimension (W*H*D)	131.0mm*100.5mm*46.0mm			
		Weight (KG)	0.3			
	Environment	Vibration Resistance	IEC61131-2 Standard			
		Storage Temperature	-20°C~70°C			
Working Temperature		-10°C~60°C				
Relative Humidity		10~85%RH (Non-condensing)				
	CE Certification	CE Marked				
	FCC Certification	FCC Class A				
Software	Real-time Monitoring Points	300	300	500	600	
	Alarm Monitoring Points	200	200	300	300	
	History Monitoring Points	50	50	100	100	
	History Storage	90 days	90 days	180 days	180 days	
	Normal Pass-through	YES				
	VPN Pass-through	N/A	N/A	YES	YES	
	Edge Computing	YES				
	API Interface	YES				
	Remote Update	YES				
	Configuration download / upload	YES				
	Off-line Transmission	YES				
	GPS	Optional				

# Installation Dimensions

Unit : mm

## V-BOX S-00/AG/SG

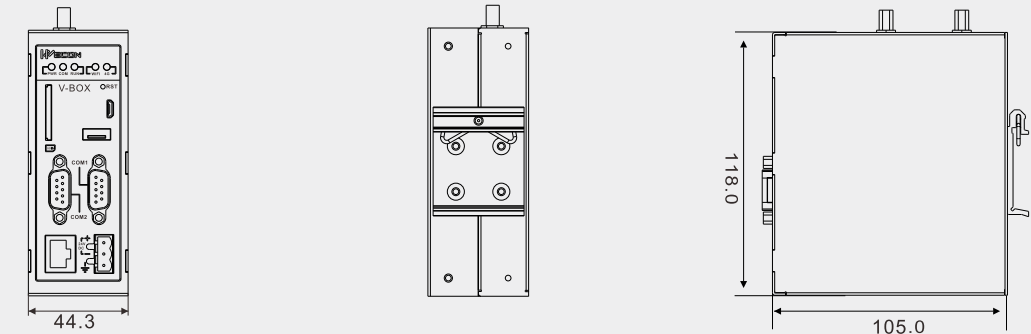

## V-BOX S-3N/NG/PG

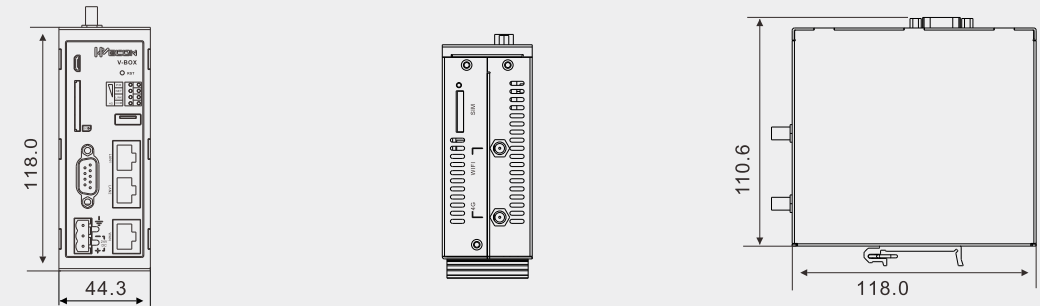

## V-BOX E-00/2G/4G

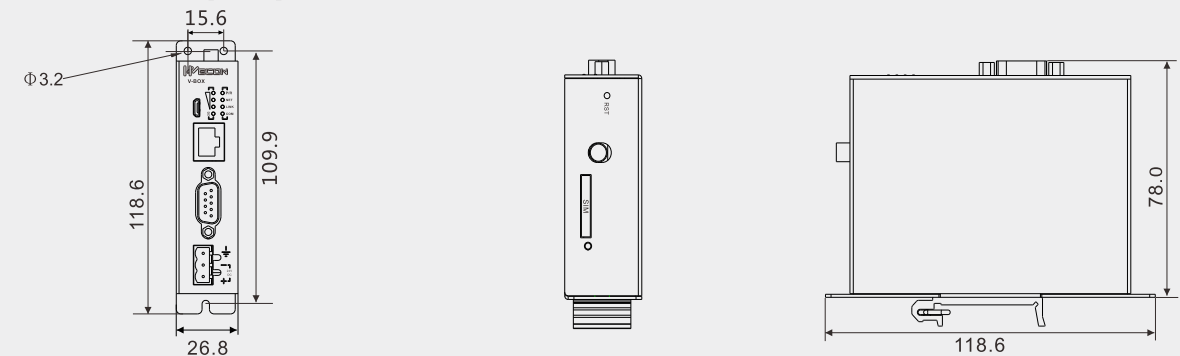

## V-BOX H-00/WF/4G/AG

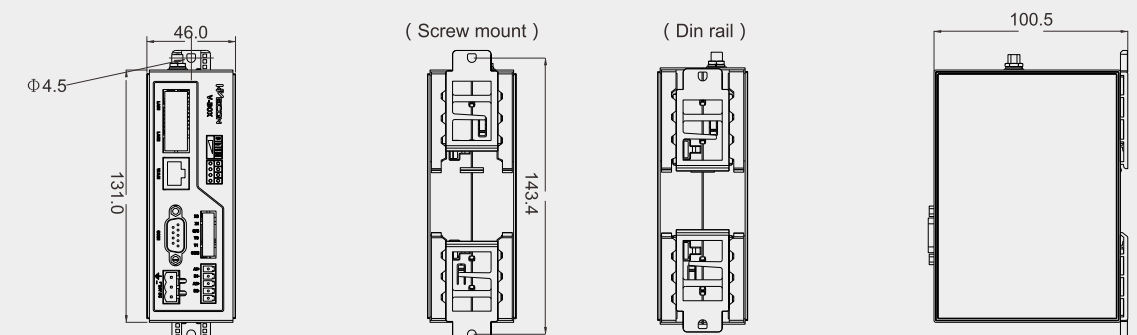



# Industrial Heating System Application

## Background

As the country pays more and more attention to environmental protection, it is an inevitable trend in the heating industry to use electricity instead of coal.

Electric boiler control is increasingly demanding for safety, environmental protection and energy saving, intelligent control, and centralized management and convenient production management are becoming more and more urgent.

- Need to monitor the devices status and real-time data, to realize online monitoring and metering of the heating system. The equipment failure should be reported timely, and remote control and maintenance can be timely performed.

- Based on environmental protection and intelligent management, devices data needs to be uploaded to the information management system, which can be monitored, maintained, and observed with multiple interfaces and multiple devices to achieve remote operation.

## Solution

WECON IIoT V-BOX solution realizes remote monitoring, timely gets equipment failure message, and optimizes management.

### Intelligent remote control

- User can monitor and control the device running status in real time through PC and mobile APP, even far away from it.
- The cloud configuration can realize remote monitoring and debugging, timely catch and resolve equipment operation failures, improve the efficiency of service operation maintenance.
- If to device failures, the alarm message could be sent to mobile APP, WeChat, and E-mail.

### Devices operation records

- Using maps to show the distribution area of heating devices, and counting the number of running operating devices, the number of shutdown devices, the devices failure rate, and various statistical analysis reports;
- Recording operating data and alarm message in real time, so that to provide Big-data basis for system maintenance and transformation.



# Oxygen Making Equipment Application

## Background

Oxygen making equipment uses air separation technology to produce oxygen, which is widely used in industrial oxygen production, domestic oxygen production and medical oxygen production. At present, the professional requirements of oxygen production equipment are getting higher, and stricter quality control is required. Fast startup, low energy consumption, simple and flexible operation, network monitoring, real-time monitoring, and multiple working modes are necessary.

- Need to realize the automatic production process and visible screens.
- Integration and transmission of data such as production line station equipment processing data, daily planning progress and other management systems and control systems.
- Realizing the data connection and management with the third-party platform.

## Solution

### ● Auto and real-time monitoring

Real-time monitoring of data. Offline transmission ensures that data is always online and works stably in an unattended state.

### ● Remote management

It can centrally monitor, debug, upgrade, and maintain the field equipment of various projects scattered throughout the country or globally. Technical engineers can remotely debug equipment, reducing service costs and improving management efficiency.

### ● Multi-media monitoring

Both V-NET system and mobile APP can realize remote control and global management. As long as there is a network, whether you are on a business trip or a meeting, you can control the operating status of the device anytime, anywhere.

### ● Alarm mechanism

Recording equipment alarm information. Through alarm notification( such as WeChat, E-mial notification, and smart APP) to improve the troubleshooting efficiency, upgrade equipment alarm management and maintenance management.

### ● Authority management

The administrator account can perform authorization management for staff according to actual needs to protect data, management systems, and illegal operations, so that to ensure the safe operation of the system.

### ● Multi-media monitoring

Recording equipment alarm information. Through alarm notification( such as WeChat, E-mial notification, and smart APP) to improve the troubleshooting efficiency, upgrade equipment alarm management and maintenance management.

### ● Multi-media monitoring

Both V-NET system and mobile APP can realize remote control and global management. As long as there is a network, whether you are on a business trip or a meeting, you can control the operating status of the device anytime, anywhere.

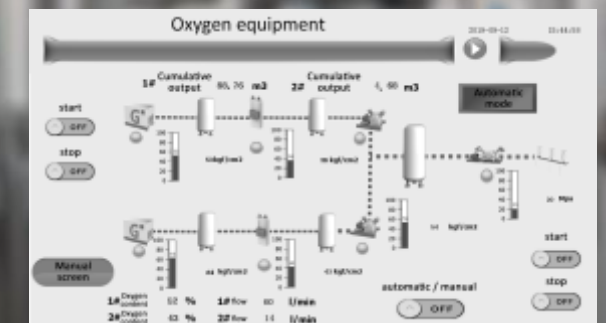



# Data-Mapping Application

## Background

With the change and development of technology, more and more manufacturing companies have begun to invest in intelligent automation control equipment, reducing manual intervention, increasing production capacity and improving quality.

The most critical part of intelligent device control is the linkage between devices (M2M: Machine-to-Machine), data interaction between the device and the monitoring system (M2S: Machine-to-System).

- The linkage between devices control, only one device (PLC) is operated, and other devices (PLC) follow the main one.
- When main production line runs, rest of production lines also run synchronously.
- Data is interacting between multiple devices, as well as multiple production lines.

## Solution

V-BOX Data-Mapping Mode can realize data interaction between different brands of PLCs, and can also realize data interaction between MES system and SCADA system and equipment, without any cloud platform. The mapping mode provides the technical solutions of M2M and M2S. Two mapping modes: Local Mapping and Networking Mapping.

**Local mapping:** Multiple COM port on a single V-Box, each COM port can be connected to different control devices. Data interaction can be realized from devices connected by different COM ports, switch control, data read and write by using LUA script.

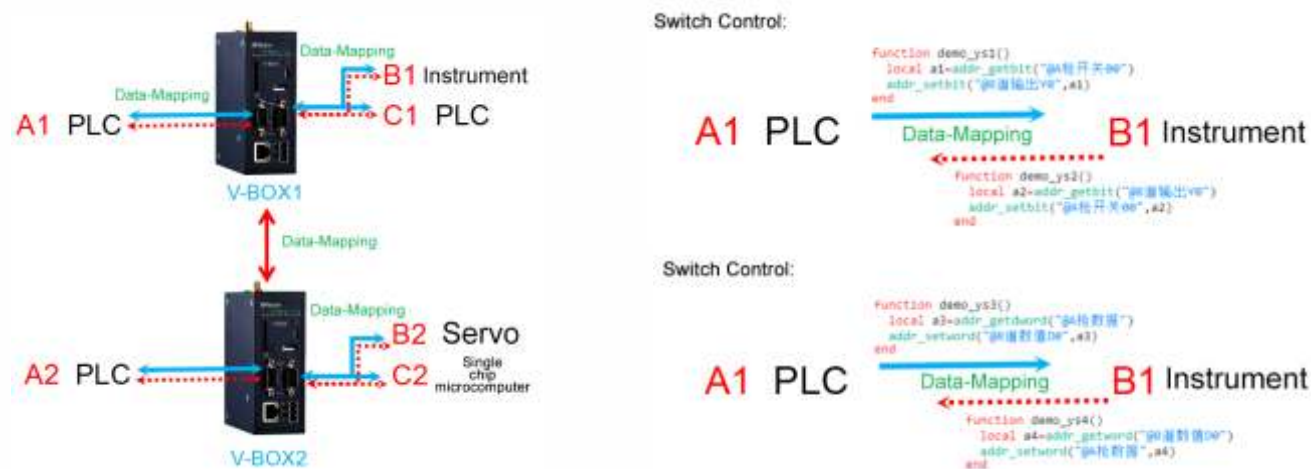

**Network mapping:** Realize mutual control and data interaction of multiple COM ports between multiple V-BOX by this mode; Synchronous monitoring and operation.

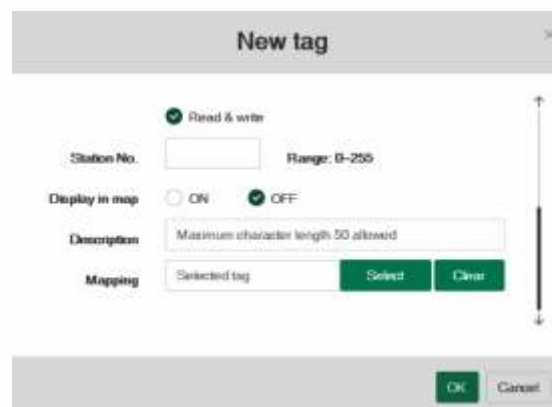

**Note:** V-BOX supports more than 300 protocols, it can realize the protocol conversion between different PLCs, instruments, meters, and microcontrollers by Date-Mapping Mode.

# Cloud-Mode Application

## Background

### What is Cloud-Mode?

- V-NET and Web SCADA are basic cloud platforms that cannot meet complex requirements. Cloud-Mode can work with experienced software companies in various industries to complete such projects;
- Requires skilled programming ability, data can only be saved on own server, V-BOX needs to connect with this server where local area network supported;
- There are many choices for IoT platform in the market. We could cooperate with those IoT service providers in Cloud-Mode which provide more choice for end-users.

WECON V-BOX Cloud-Mode, can quickly access third-party cloud platforms through simple configuration and writing LUA scripts. When the cloud service is upgraded, the device needs to adjust the data collection and reporting logic. As long as the configuration is modified through the Cloud-Mode, the service can be upgraded without upgrading the firmware. In general, V-BOX Cloud-Mode is more flexible and versatile than other similar products in the market.

## Application

- It is not possible to give desired solution by general devices management platform.
- The universal device management platforms cannot be 100% fit to the unique operation mode and workflow of the enterprises;
- Many kinds of public or private protocols are applied in the distributed field devices, so the universal software is not possible to be compatible with all devices;
- The brand platform operates under the company's brand, and the universal platform requires secondary development.



- In the field of industrial communication, MQTT is well-known and accepted by end-users. V-BOX can be connected with on-demand cloud platform by using MQTT in Cloud-Mode.
- Different rules for authentication, collection, and reporting of different cloud platform providers.
- Easily implement requirements by LUA script.
- Users can experience the functions they need on different platforms.

# PLC Protocols Supported

Brand	Serial Port
Liquid Level Meter	Liquid_Level_Meter, Liquid_Level_Meter_MT510
INVT	INVT_IVC1, INVT_IVC2L, INVT_IVC2H, GD10_Transducer, GD800_Transducer
PRINTER	WH-AXX/EXX/AA-XXE8XX, RD-DXX/EXX, SP-RMDXX/RMEXX/DVII
VIGOR	VIGOR PLC
YD	YD AIBU SPROTOCOL
Xinjie	Xinjie XC ModBus, Xinjie FC ModBus, Xinjie XD/XE ModBus
Facon	Facon FB Series(RS232/RS485) ModBus, Facon FB Series(RS232-RTS) ModBus
Fuji	Fuji_SPB
	Crouzet Automatismes SAS: CROUZET M3(FBD)
ModBus	ModBus RTU Slave(All Fuction), ModBus RTU Slave(All Fuction OneBaseAddress), ModBus RTU Master, ModBus(ASCII) Slave, ModBus ASCII Master
Yamatake	Yamatake CPL
MIKOM	MIKOM MX Series PLC
Microcomputer Protection	Microcomputer Protection
Siemens	Siemens S7-200 CPU22x/Smart PPI, Siemens S7-300(with PC Adaptor)
Tadele	Tadele MSD 300
Allen-Bradley	Allen-Bradley DF1, Allen-Bradley DF1 Advanced, Allen-Bradley MicroLogix, Allen-Bradley Compactlogix DF1
IDEC	IDEC MicroSmart PROTOCOL
Nardi Elettronica	Nardi ModBus RTU Slave(All Fuction), Nardi ModBus RTU Slave(Read One Len), Nardi ModBus RTU Slave(All Fuction OneBaseAddress), Nardi ModBus(ASCII) Slave, Nardi ModBus(ASCII)Slave(Read One Len), Nardi ModBus RTU Master, Nardi ModBus ASCII Master
VIGORVS	VIGOR VSPLC
Taian	BANNER BSP, Taian AP-300 ModBus
FATEK	FATEK ASCII
Schneider-Electric	Schneider-Electric Twido ModBus, Modicon ModbusRTU, Schneider_TELWAY
HollySys	HollySys LK Modbus RTU, HollySys LM Modbus RTU
megmeet	megmeet
Mitsubishi	MIT FX NOPROTOCOL, MIT FX NOPROTOCOL(FX1s\FX0n), MIT FX1N NOPROTOCOL, MIT FX2N NOPROTOCOL, MIT FX3U/3G/3SA NOPROTOCOL, MIT FX PROTOCOL, MIT FX2N 485BD/ADP, MIT Q02H CPU Port PROTOCOL, MIT L02 CPU Port PROTOCOL, MIT FX5U

# PLC Protocols Supported

RKC	Rkc_CDCH
Emerson	Emerson 984 RTU Slave ModBus
OMRON	OMRON HOSTLINK, OMRON CS1(CP1E/CP1H), OMRON CV/CJ1M/CS1H
Keyence	Keyence_KV1000, Keyence KV-700/3000/5000, Keyence_KV_16DT, Keyence KV-700/3000/5000/KV1000 MultlRead
Delta	Delta Controler PROTOCOL, Delta Controler ASIIC HexAddr, Delta DVP OneLen PROTOCOL, Delta DVP PROTOCOL, Delta DVP PROTOCOL HexAddr
Other Protocol	YuDa PLC, DLT645Meter
Haiwell	Haiwell PLC Series
NAIS	NAIS FP MEWTOCOL, NAIS FP MEWTOCOL(Bit NO Dot)
wonway	wonway
Koyo	Koyo_K, Koyo Direct
REGIN	REGIN
LG	LG MASTER K120S, LG MASTER K300S, LG XBC/XBM/XGB/XGK CPU DIRECT, LG Inverter(LG-BUS ASCII), LG MASTER-K CNet
INOVANCE	Inovance H1u Plc, Inovance H2u Plc, Inovance H3u Plc
WECON	WECON LX1S WECON LX2N, WECON LX2V, WECON LX2E, WECON LX3V, WECON LX3VP, WECON LX3VM, WECON LX3VE

Brand	Ethernet Port
ModBus	ModBus TCP Slave(All Fuction), ModBus TCP Master, ModBus ASCII TCP Slave, ModBus ASCII TCP Master, ModBus RTU Slave(ETH)
Delta	Delta_AS300_TCP, Delta_DVP_ModbusTCP
FATEK	FATEK TCP ASCII
Schneider-Electric	Schneider MODBUS TCP/IP
Siemens	Siemens S7-200 Smart(Ethernet), Siemens S7-200(Ethernet With243), Siemens S7-300 Ethernet, Siemens S7-300 Ethernet Basic, Siemens S7-1200 Ethernet, Siemens S7-xxx Ethernet
Mitsubishi	MIT QJ71E71 MELSEC PROTOCOL, MIT L02 CPU MELSEC PROTOCOL, MIT FX5U Ethernet
Allen-Bradley	Allen-Bradley Ethernet DF1, Allen-Bradley EthernetIP-DF1
LG	LG XGK FEnet(Ethernet)
Nardi Elettronica	Nardi ModBus TCP Slave(All Fuction), Nardi ModBus TCP Master
OMRON	OMRON CJ UDP FINS Ethernet, OMRON CJ TCP FINS Ethernet
Keyence	KEYENCE KV-5000(Ethernet), KEYENCE KV-7500(Ethernet)

Remark: Able to Customized protocols according to users's needs.